

PROGRAMMING BINDER

Shepard's District: LGBTQIA+ Housing



North Dakota State University
ADHM 351
Maxwell Pickett

Table of Contents

Scope of Work.....	2
User Description	2
Goals and Objectives.....	3
Design Concept Statement.....	5
Room Data Sheets.....	5
Adjacency Matrix.....	8
Adjacency Diagram.....	9
Bubble Diagram	10
Blocking Diagram.....	11
Circulation Diagram	12
F, F, & E Schedule.....	13
Room Finish Schedule.....	23
Lighting Schedule	28
Ideation/Schematic Sketches.....	30
Study Model - 3D Model.....	31
Works Cited.....	34

DISTRICT

L G B T Q I A + H o u s i n g

Scope of Work

As the Interior Designer of Shepard's District, one will work to connect with the focus group. The designer will work with other designers and undergo preliminary stages. The designer will pursue research, multiple preliminary sketches, concept boards, color boards, and select furniture pieces. Once a final concept has been understood and decided on between the staff of the Shepard's District and the Designer, the Designer starts the final phases of the project. Once the final phases of the project have been started, all work is mandatory to completion. Final phases include a full set of Construction Documents modeled using AutoCAD, final interior perspectives created using SketchUp and final touches through Enscape to create realistic viewing. The client will be able to view the space through Virtual Reality if desired. Presentation boards will be produced of the final perspectives along with research and furniture and fixtures and equipment. The final portfolio presented to the client will include: Full set of Construction Documents, Presentation Folio, Programming Binder, Research Binder, Presentation Boards, and an All Gender Family Spec Book.

User Description

The users of Shepard's District are members of the LGBTQIA+ community. These individuals are vulnerable and broken. They have been or were kicked out of their homes because of their emotional and physical identification. Users need a space that they can enter and be welcomed with an invisible hug of design. The people that will inhabit the interior environment will be able to stay for as long as they need or until they find a support system that will uplift them positively. Throughout everyone's time at Shepard's District, the goal is that they have had an experience of healing, positivity, and a sense of community and family.

Goals and Objectives

1. Develop a highly inclusive design that represents the community members in a comfortable and positive interior environment.
 - a. Maintain a colorful-neutral palette that harvests comfort for the user.
 - b. Utilize inclusive design attributes and create a space that is open to every individual that is welcomed.
 - c. Use the kitchen island as an island and dining area to reinforce community and inclusivity.
2. Create an overall interior space that is conducive for the process of healing, easing of pain, and immersion of positivity.
 - a. Create a lighting scenario that is conducive for healing.
 - b. Use dimmable switches and maintain a warm a color temperature.
 - c. Use patterns that help guide the viewers' attention with a positive distraction.
3. Design supportive space that offer the ability for special services and opportunities.
 - a. Have access to a Nurse on staff in the building at different times of the week.
 - b. Have access to a Counselor on staff in the building at different times of the week.
 - c. Create separate sleeping spaces for the guest of Shepard's District to ensure safety.
4. Create a color palette that is vibrant and welcoming yet still sophisticated.
 - a. Use muted colors to maintain a sophisticated palette.
 - b. Utilize colors such as greys, muted olive greens, and muted blues.
 - c. Keep the environment vibrant by having access to natural light and using painted cabinets instead of stained wood.

5. Discover the concepts that form the personal feeling of family through a non-biological group of individuals.
 - a. Research the concepts that form personal feelings of family.
 - b. Utilize research to create the desired accepting space that the individuals need for proper healing and personal belonging.
 - c. Design a living space that groups all the individuals together to enhance a community.
6. Design an interior environment that lets the user create a sense of individuality
 - a. Use a simple color palette.
 - b. Leave walls blanks so users can personalize through use of Command Hooks.
 - c. As a designer, create an environment that is aesthetically beautiful and personable to every user.
7. Create an experience for the user that is welcoming and not overwhelming
 - a. Use a cool color palette.
 - b. Utilize straight lines through the design in the interior environment. This can be seen in situations such as cabinetry, layout, furniture, etc.
 - c. Keep the use of patterns in sleeping areas to a minimum to enhance a space that is tranquil.
8. Develop a sophisticated design that speaks to the LGBTQIA+ youth and is fun to all that inhabit the space.
 - a. Examine furniture pieces such as sectional sofas covered in thick comfy upholsteries.
 - b. Create an intricate color palette that involves muted colors.
 - c. Research and listen to homeless youth, take their thoughts into consideration when designing the space.

Design Concept Statement

The interior environment of Shepard's District has been designed reflect the mission of affordable supportive housing. To embrace this mission the designers developed a space that functions, has a community area, and residential units. These areas are meant to bring members together to support, encourage, mentor, care for, and guide each other. Inside this interior environment the designers worked to create spaces that would contribute to the success of the users. These positive spaces will be program enriched to provide valuable resources and opportunities. Throughout the space one will find bold and subtle textiles, unique wallcoverings, comfortable furniture, and create designs that fill the area with warmth and the mood for growth and love.

Room Data Sheets

Room/Area Name: Mud/Entry		
Users: Residents of Shepard's District		
Activities: Entrance and Exit of Unit		
Furniture: • Built-in Locker Storage	Heating/Ventilation/AC: • Central AC • Heating	Flooring: • Wood Flooring
Equipment/Appliances: • N/A	Plumbing/Fixtures: • Recessed Cans	Wall Partition(s): • N/A
Hours of Use: • All hours of the day	Communication: • Wi-Fi	Ceiling: • Gypsum • Painted
Special Provisions: • Entry Rug	Electrical: • Light Switches • 120 Receptacles • Light Fixtures	Doors/Windows: • Front Door
Occupant Classification & Occupant Load Per Room: • 4	Room Size: • 50 sq. ft.	Natural Lighting & Natural Lighting Controls: • Windows and Curtains

Room/Area Name: Kitchen/Dining		
Users: Residents of Shepard's District		
Activities: Gathering for Meals, Discussion, Gathering Space		
Furniture: • Counter Height Bar Stools	Heating/Ventilation/AC: • Heating • Central AC	Flooring: • Wood Flooring
Equipment/Appliances: • Refrigerator • Dishwasher • Oven and Stove Top • Microwave	Plumbing/Fixtures: • Double Sink • Kitchen Faucet • Dishwasher	Wall Partition(s): • N/A
Hours of Use: • All hours of the day	Communication: • Wi-Fi	Ceiling: • Gypsum • Painted
Special Provisions: • N/A	Electrical: • Recessed Cans • Pendants	Doors/Windows: • Living Room Windows
Occupant Classification & Occupant Load Per Room: • 6	Room Size: • 150 sq. ft.	Natural Lighting & Natural Lighting Controls: • Windows and Curtains

Room/Area Name: Living Room		
Users: Residents of Shepard's District		
Activities: Gathering Space, Work on Homework, Play Games, Watch Movies, Communicate with one another.		
Furniture: • Sofa • Armchair • Side Tables (2) • Rug	Heating/Ventilation/AC: • Heating • Central AC	Flooring: • Wood Flooring
Equipment/Appliances: • T.V.	Plumbing/Fixtures: • N/A	Wall Partition(s): • N/A
Hours of Use: • Evenings	Communication: • Wi-Fi	Ceiling: • Gypsum • Painted
Special Provisions: • Area Rug	Electrical: • Recessed Cans	Doors/Windows: • Windows (2)
Occupant Classification & Occupant Load Per Room: • 6	Room Size: • 150 sq. ft.	Natural Lighting & Natural Lighting Controls: • Windows and Curtains

Room/Area Name: Bathroom(s)		
Users: Residents of Shepard's District		
Activities: Use Toilet, Cleanse Body		
Furniture: • N/A	Heating/Ventilation/AC: • Heating • Central AC	Flooring: • Mosaic Tile Flooring
Equipment/Appliances: • N/A	Plumbing/Fixtures: • Toilet • Shower/Tub Combo • Bathroom Sink • Bathroom Faucet	Wall Partition(s): • N/A
Hours of Use: • Mornings • Evenings	Communication: • Wi-Fi	Ceiling: • Gypsum • Painted
Special Provisions: • N/A	Electrical: • Recessed Cans • Recessed Can Fan • Vanity Light	Doors/Windows: • Doors
Occupant Classification & Occupant Load Per Room: • 2	Room Size: • 100/150 sq. ft.	Natural Lighting & Natural Lighting Controls: • N/A

Room/Area Name: Bedroom(s)		
Users: Residents of Shepard's District		
Activities: Relax, Sleep		
Furniture: • Bed Frame • Mattress • Closet with Dresser	Heating/Ventilation/AC: • Heating • Central AC	Flooring: • Carpet Tile
Equipment/Appliances: • N/A	Plumbing/Fixtures: • N/A	Wall Partition(s): • N/A
Hours of Use: • Early Mornings • Evenings	Communication: • Wi-Fi	Ceiling: • Gypsum • Painted
Special Provisions: • N/A	Electrical: • Surface Mounted Chandelier	Doors/Windows: • Doors • Windows
Occupant Classification & Occupant Load Per Room: • 2	Room Size: • 100 sq. ft.	Natural Lighting & Natural Lighting Controls: • Windows and Curtains

Adjacency Matrix

	ENTRY	LOCKER STORAGE	KITCHEN	LIVING AREA	FIRST BEDROOM	SECOND BEDROOM	THIRD BEDROOM	MAIN BATHROOM	SECOND BATHROOM
ENTRY									
LOCKER STORAGE	Primary/Mandatory								
KITCHEN		Primary/Mandatory							
LIVING AREA	Secondary/Desirable		Primary/Mandatory						
FIRST BEDROOM	Undesirable								
SECOND BEDROOM	Undesirable								
THIRD BEDROOM	Undesirable								
MAIN BATHROOM			Secondary/Desirable	Primary/Mandatory			Primary/Mandatory		
SECOND BATHROOM			Undesirable		Secondary/Desirable	Secondary/Desirable		Secondary/Desirable	

KEY	
Primary/Mandatory	Primary/Mandatory
Secondary/Desirable	Secondary/Desirable
Undesirable	Undesirable
Neutral	Neutral

Adjacency Diagram

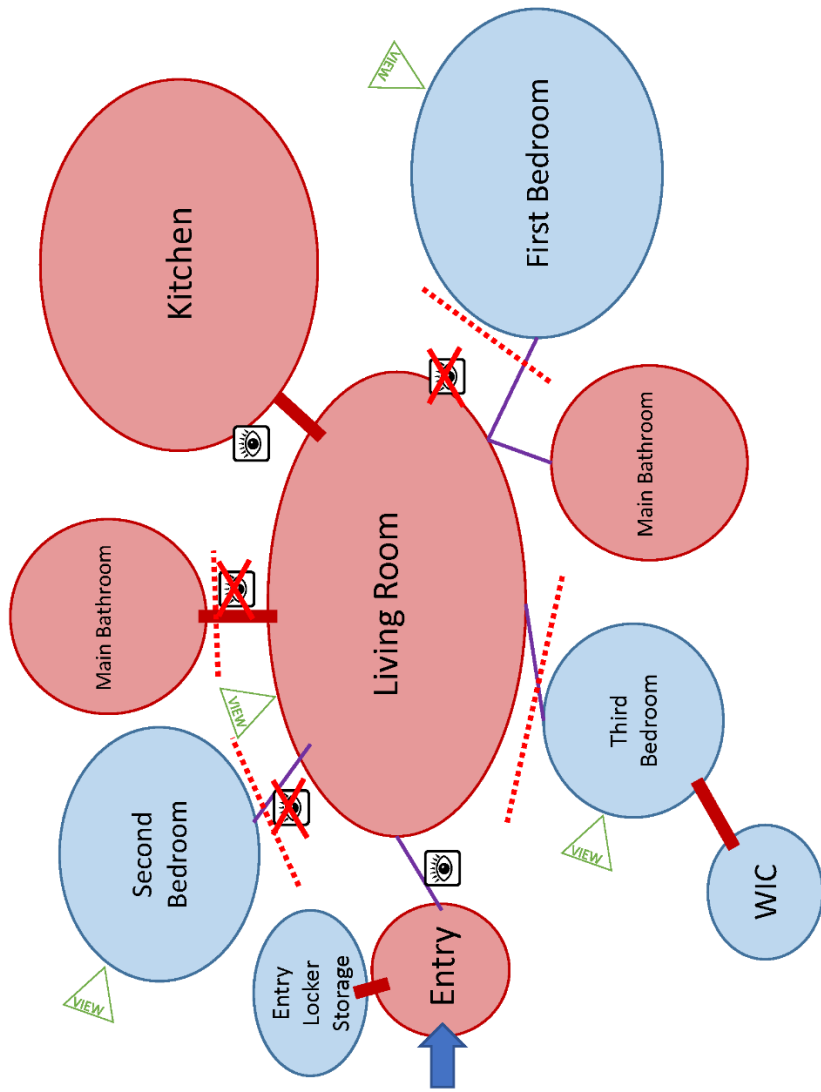

Adjacency Diagram

KEY	
	Primary/Mandatory Adjacency
	Secondary/Desirable Adjacency
	Visual Separation
	Interior View Consideration
	Exterior View Consideration
	Acoustical Separation
	Main Entrance
	Private Area
	Public Area

Bubble Diagram

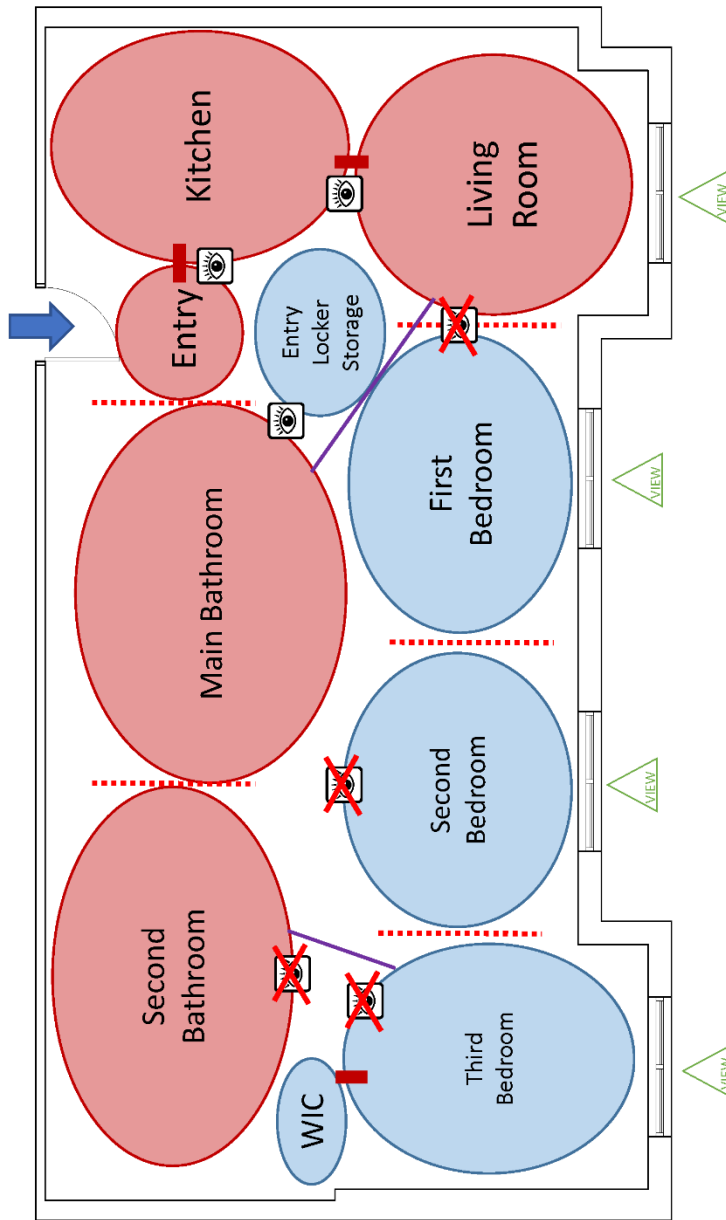

Bubble Diagram

KEY	
	Primary/Mandatory Adjacency
	Secondary/Desirable Adjacency
	Visual Separation
	Interior View Consideration
	Exterior View Consideration
	Acoustical Separation
	Main Entrance
	Private Area
	Public Area

Blocking Diagram

Blocking Diagram

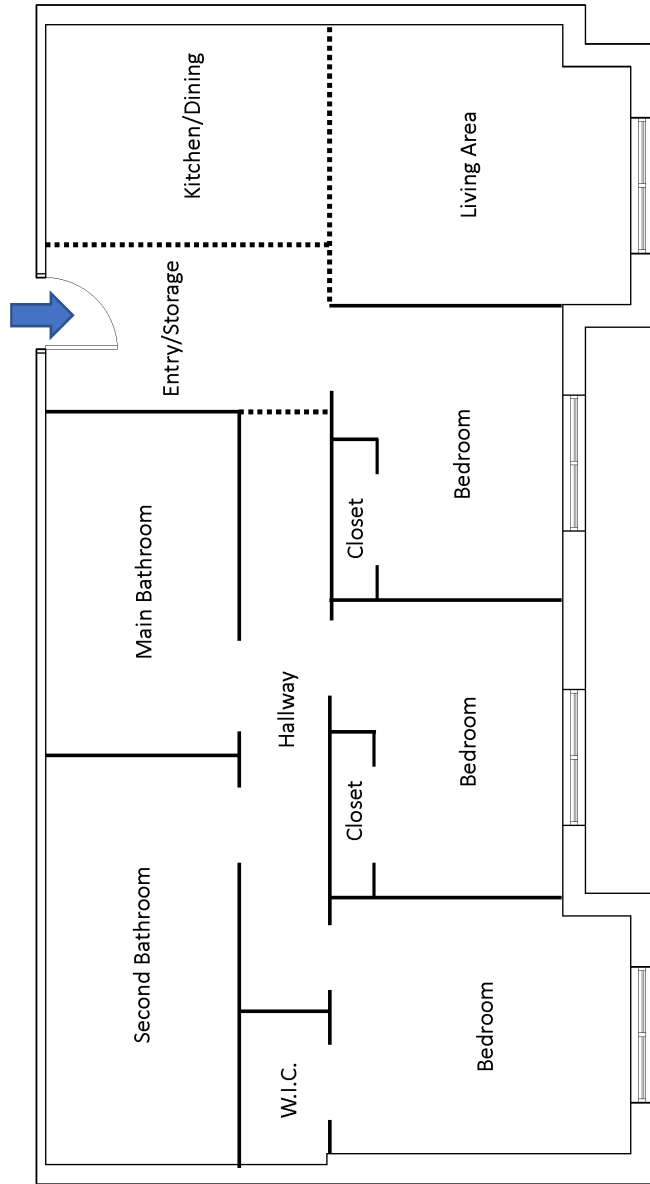



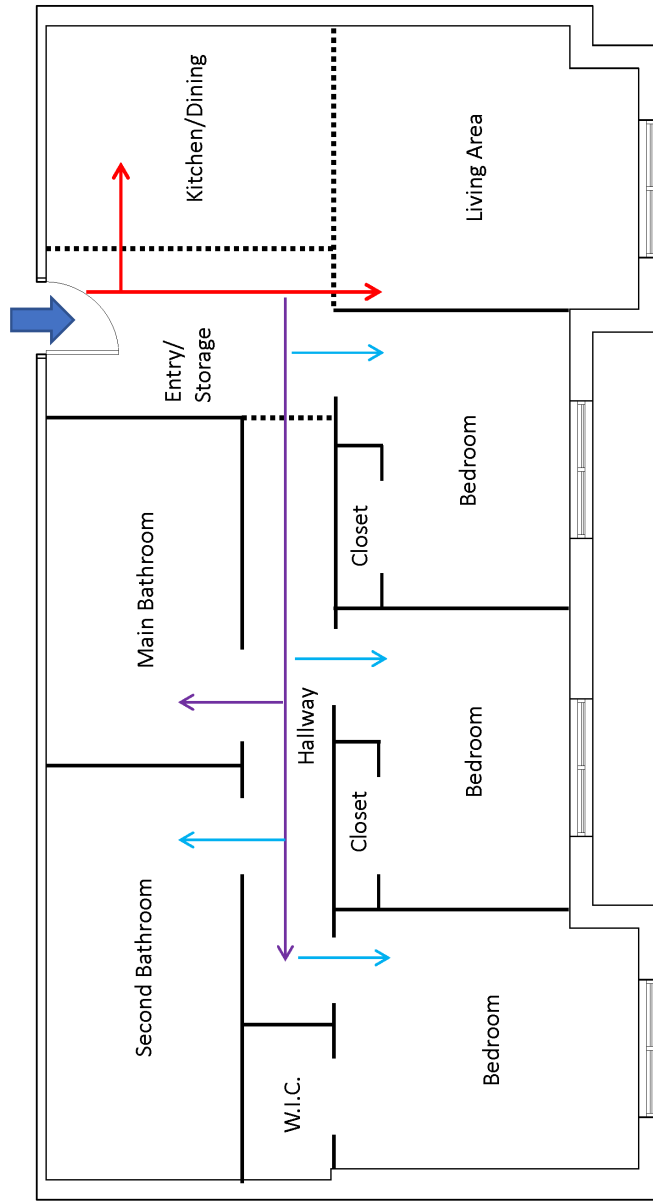

KEY	
	Main Entrance
—	Wall
....	Space allocated but not defined by a wall or built-in divider

Circulation Diagram

Circulation Diagram





KEY	
	Main Entrance
	Wall
	Space allocated but not defined by a wall or built-in divider
	Primary Circulation Path
	Secondary Circulation Path
	Tertiary Circulation Path



F, F, & E Schedule

FF&E Schedule		
Code	AP-1	
Description	Refrigerator	
Manufacturer	Whirlpool	
Item/Model Name	36" w Counter Depth French Door Refrigerator - 24 cu. ft.	
Item/Model Number	WRF757SDHZ	
Dimension/Size	36" w x 72" h x 31.5" d	
Quantity	6	
Product Finish/Color	Fingerprint Resistant Stainless Steel	
Fabric Code	N/A	
Fabric Pattern Name/Number	N/A	
C.O.M. Description/Manufacturer Description	N/A	
Location	Kitchen	
Notes	Energy Star® certified, UL Listed, Kosher Consumer Friendly	

FF&E Schedule		
Code	AP-2	
Description	Dishwasher	
Manufacturer	Whirlpool	
Item/Model Name	Stainless Steel Tub Dishwasher with Third Level Rack	
Item/Model Number	WDT970SAHZ	
Dimension/Size	23-7/8" w x 34-1/2" h x 24-1/2" d	
Quantity	6	
Product Finish/Color	Fingerprint Resistant Stainless Steel	
Fabric Code	N/A	
Fabric Pattern Name/Number	N/A	
C.O.M. Description/Manufacturer Description	N/A	
Location	Kitchen	
Notes	Energy Star® certified, UL Listed, Kosher Consumer Friendly, NSF® Certified, Hidden Controls	

FF&E Schedule		
Code	AP-3	
Description	Range	
Manufacturer	Whirlpool	
Item/Model Name	6.4 cu. ft. Smart Slide-in Electric Range with Scan-to-Cook Technology	
Item/Model Number	WEEA25H0HN	
Dimension/Size	30" w x 36" h x 24" d	
Quantity	6	
Product Finish/Color	Fingerprint Resistant Stainless Steel	
Fabric Code	N/A	
Fabric Pattern Name/Number	N/A	
C.O.M. Description/Manufacturer Description	N/A	
Location	Kitchen	
Notes	Energy Star® certified, UL Listed, Kosher Consumer Friendly, ADA Compliant, AquaLift® Self Clean	

FF&E Schedule		
Code	AP-4	
Description	Built-in Microwave	
Manufacturer	Whirlpool	
Item/Model Name	1.1 cu. ft. Low Profile Microwave Hood Combination	
Item/Model Number	WML75011HZ	
Dimension/Size	29-7/8" w x 10-5/16" h x 18" d	
Quantity	6	
Product Finish/Color	Fingerprint Resistant Stainless Steel	
Fabric Code	N/A	
Fabric Pattern Name/Number	N/A	
C.O.M. Description/Manufacturer Description	N/A	
Location	Kitchen	
Notes	Energy Star® certified, UL Listed, Kosher Consumer Friendly	

FF&E Schedule		
Code	BD-1	
Description	Bed Frame	
Manufacturer	Room & Board: Business Interiors	
Item/Model Name	Chilton Bed	
Item/Model Number	N/A	
Dimension/Size	63" w x 86" d (Queen)	
Quantity	16	
Product Finish/Color	Natural Live Edge Wood: Spalted Sugarberry, Steel	
Fabric Code	N/A	
Fabric Pattern Name/Number	N/A	
C.O.M. Description/Manufacturer Description	N/A	
Location	Bedrooms	
Notes	Disclaimer: Each wood headboard is unique	

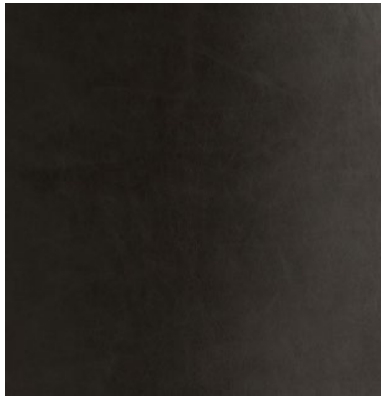
FF&E Schedule		
Code	C-1	
Description	Arm Chair	
Manufacturer	Arteriors Contract	
Item/Model Name	Seger Chair Faux Graphite Leather - Grey Ash	
Item/Model Number	8013	
Dimension/Size	29.5" w x 35" h x 32" d	
Quantity	20	
Product Finish/Color	Grey Ash	
Fabric Code	FB-2	
Fabric Pattern Name/Number	N/A	
C.O.M. Description/Manufacturer Description	N/A	
Location	Living Rooms, Bedrooms	
Notes	Lead Time of 60 days	

FF&E Schedule		
Code	C-2	
Description	Counter Stool	
Manufacturer	Design Within Reach	
Item/Model Name	One More Counter Stool	
Item/Model Number	689762	
Dimension/Size	15"w x 18"d x 25.5"sh x 39.25"oh	
Quantity	24	
Product Finish/Color	Transparent Polycarbonate	
Fabric Code	N/A	
Fabric Pattern Name/Number	N/A	
C.O.M. Description/Manufacturer Description	N/A	
Location	Kitchen	
Notes	Designed by Philippe Starck for Kartell	

FF&E Schedule		
Code	FC-1	
Description	Kitchen Faucet	
Manufacturer	American Standard	
Item/Model Name	Colony PRO Collection	
Item/Model Number	7074.550.002	
Dimension/Size	12.5"h	
Quantity	6	
Product Finish/Color	Polished Chrome (002)	
Fabric Code	N/A	
Fabric Pattern Name/Number	N/A	
C.O.M. Description/Manufacturer Description	N/A	
Location	Kitchen	
Notes	Flow Rate: 1.5 GPM, ANSI A117.1, ASME A112.18.1, CSA B125.1, NSK 61/Section 9, NSF 372, ADA Compliant	

FF&E Schedule		
Code	FC-2	
Description	Bathroom Faucet	
Manufacturer	American Standard	
Item/Model Name	Edgemere Collection: Two-Handle Centerset Bathroom Faucet	
Item/Model Number	7018.201.002	
Dimension/Size	7-5/16" h x 9-5/8" w	
Quantity	14	
Product Finish/Color	Polished Chrome (002)	
Fabric Code	N/A	
Fabric Pattern Name/Number	N/A	
C.O.M. Description/Manufacturer Description	N/A	
Location	Bathroom	
Notes	Flow Rate: 1.2 GPM, ANSI117.1, ASME A112.18.1, CSA B125.1, NSF 61/Section 9, NSF 372, ADA Compliant	



FF&E Schedule		
Code	FC-3	
Description	Shower Faucet	
Manufacturer	American Standard	
Item/Model Name	Edgemere Collection: Tub and Shower Trim Kit with Cartridge	
Item/Model Number	TU018502.002	
Dimension/Size	N/A	
Quantity	12	
Product Finish/Color	Polished Chrome (002)	
Fabric Code	N/A	
Fabric Pattern Name/Number	N/A	
C.O.M. Description/Manufacturer Description	N/A	
Location	Bathroom	
Notes	Flow Rate: 2.5 GPM, ASSE 1016, ASME A112.18.1016, CSA B125.16, ASME A12.18.1, CSA B125.1, ADA Compliant	

FF&E Schedule		
Code	FX-1	
Description	Toilet Paper Holder	
Manufacturer	American Standard	
Item/Model Name	Edgemere Collection: Toilet Paper Holder	
Item/Model Number	7018.230.002	
Dimension/Size	7-1/2" w x 1-13/16" h x 3-5/8" d	
Quantity	11	
Product Finish/Color	Polished Chrome (002)	
Fabric Code	N/A	
Fabric Pattern Name/Number	N/A	
C.O.M. Description/Manufacturer Description	N/A	
Location	Bathroom	
Notes	N/A	

FF&E Schedule		
Code	FX-2	
Description	Towel Holder	
Manufacturer	American Standard	
Item/Model Name	Edgemere Collection: Towel Ring	
Item/Model Number	7018.180.002	
Dimension/Size	7-1/4" w x 8" h x 2-7/8" d	
Quantity	14	
Product Finish/Color	Polished Chrome (002)	
Fabric Code	N/A	
Fabric Pattern Name/Number	N/A	
C.O.M. Description/Manufacturer Description	N/A	
Location	Bathroom	
Notes	N/A	

FF&E Schedule		
Code	FX-3	
Description	Towel Bar	
Manufacturer	American Standard	
Item/Model Name	Edgemere Collection: 24" Towel Bar	
Item/Model Number	7018.024.002	
Dimension/Size	25-13/16" w x 4-1/16" d	
Quantity	11	
Product Finish/Color	Polished Chrome (002)	
Fabric Code	N/A	
Fabric Pattern Name/Number	N/A	
C.O.M. Description/Manufacturer Description	N/A	
Location	Bathroom	
Notes	N/A	

FF&E Schedule		
Code	M-1	
Description	Mirror	
Manufacturer	Arteriors Contract	
Item/Model Name	Ollie Mirror	
Item/Model Number	6497	
Dimension/Size	30.5" d x 2.5" w	
Quantity	14	
Product Finish/Color	Polished Nickel, Natural Iron	
Fabric Code	N/A	
Fabric Pattern Name/Number	N/A	
C.O.M. Description/Manufacturer Description	N/A	
Location	Bathrooms	
Notes	Reference Construction Documents for Placement	

FF&E Schedule		
Code	R-1	
Description	Rug for Living Area	
Manufacturer	RH Contract	
Item/Model Name	Lyra Hand-Knotted Silk Rug	
Item/Model Number	10012162 SISA	
Dimension/Size	8'w x 10'l	
Quantity	6	
Product Finish/Color	Silver/Sage	
Fabric Code	N/A	
Fabric Pattern Name/Number	10012872 SISA	
C.O.M. Description/Manufacturer Description	N/A	
Location	Living Area	
Notes	84 knots per square inch, naturally dyed yarn with double wash, GoodWeave Certified	

FF&E Schedule		
Code	S-1	
Description	Double Bowl Sink	
Manufacturer	American Standard	
Item/Model Name	Edgewater Collection: Stainless Steel Kitchen Sink	
Item/Model Number	18DB.9332211.075	
Dimension/Size	22" w x 22" l x 9" d	
Quantity	6	
Product Finish/Color	Stainless Steel	
Fabric Code	N/A	
Fabric Pattern Name/Number	N/A	
C.O.M. Description/Manufacturer Description	N/A	
Location	Kitchen	
Notes	Meets ASME A112.19.3	

FF&E Schedule	
Code	S-2
Description	Bathroom Sink
Manufacturer	American Standard
Item/Model Name	Boulevard Collection: Boulevard Undercounter Sink
Item/Model Number	0610.000.020
Dimension/Size	20-1/4" w x 16" h x 8" d
Quantity	14
Product Finish/Color	White (020)
Fabric Code	N/A
Fabric Pattern Name/Number	N/A
C.O.M. Description/Manufacturer Description	N/A
Location	Bathroom
Notes	ASME A112.19.2/CSA B45.1, ADA Compliant



FF&E Schedule	
Code	SF-1
Description	Sofa Sectional
Manufacturer	Lily Jack
Item/Model Name	Boulevard Upholstered Sectional Sofa
Item/Model Number	BV12743
Dimension/Size	43" d x 28" h
Quantity	6
Product Finish/Color	Gravel
Fabric Code	FB-1
Fabric Pattern Name/Number	Burrard 3890 - 802
C.O.M. Description/Manufacturer Description	Designtex Upholstery: Content: 15% Nylon, 15% Polyester, 70% Cotton Backing: Non-woven, Polyester, Polyurethane Design: Flammability: CA TB 117-2013, Abrasion: 50,000 Wyzenbeck Double rubs, Lightfastness: 40 Hours
Location	Living Rooms
Notes	For configuration and sectional width reference the Lily Jack Sales Representative for detailed documents on arrangements.



FF&E Schedule		
Code	T-1	
Description	Side Table	
Manufacturer	Hülsta	
Item/Model Name	Contemporary Table/Walnut/Steel	
Item/Model Number	N/A	
Dimension/Size	24"w x 12"d x 22"h	
Quantity	33	
Product Finish/Color	Walnut/Steel	
Fabric Code	N/A	
Fabric Pattern Name/Number	N/A	
C.O.M. Description/Manufacturer Description	N/A	
Location	Living Room, Bedroom	
Notes	Doubles as a seating piece	

FF&E Schedule		
Code	TLT-1	
Description	Toilet	
Manufacturer	American Standard	
Item/Model Name	Optum™ Vormax™ Het Right Height® Elongated Complete Toilet	
Item/Model Number	707AA.101	
Dimension/Size	30-5/8" x 18-1/16" x 30-13/16"	
Quantity	11	
Product Finish/Color	White (020)	
Fabric Code	N/A	
Fabric Pattern Name/Number	N/A	
C.O.M. Description/Manufacturer Description	N/A	
Location	Bathroom	
Notes	ASME A112.19.2-2008/CSA B45.1-08, US EPA WaterSense® Specification for HET's, ADA Compliant, EverClean® Surface	

Room Finish Schedule

Room Finish Schedule	
Code	LVT-1
Description	Luxury Vinyl Tile in Herringbone Pattern
Manufacturer	Mohawk Group
Product/Style Name	Molveno Collection: Rigid ERT:
Product Number	C0110 Molveno Woods
Product Finish/Color	855 Toasty
Dimension/Size	7.75" w x 59.75" l
Location	Living Areas, Kitchen, Hallways
Technical Specifications	<p>Design: Static Load: ASTM F970 - Passes - modified at 1500 psi, Resistance to Chemicals: ASTM F925 - Passes - No more than a slight change, Smoke Density: ASTM E662 Part A - Less than 450</p> <p>Sustainability: Commercial Grade Rigid Enhanced Resilient Tile, FloorScore® Certified, 100% Virgin Vinyl</p>
Notes	Installed in Herringbone Pattern with a perimeter piece surrounding field area. Floating ERT with Unipush Locking System. No recommended adhesive required.



Room Finish Schedule	
Code	CPT-1
Description	Carpet Tile for Bedroom Application
Manufacturer	Mohawk Group
Product/Style Name	Lichen Collection
Product Number	GT388 Macro Bloom Tile 12BY36
Product Finish/Color	937 Frosted Shield
Dimension/Size	12" w x 36" l
Location	Bedrooms
Technical Specifications	<p>Design: Dye Method: Solution Dyed, Fiber Type: Duracolor® Tricolor Premium Nylon, Fiber Technology: Duracolor® by Mohawk Group's Stain Resistant System - Passes GSA requirements for permanent stain resistant carpet, Foot Traffic: Heavy,</p> <p>Performance: Static: AATCC-134 Under 3.5 KV, Flammability: ASTM E 648 Class 1 (Glue Down), Smoke Density: ASTM E Less than 450</p> <p>Sustainability: IAQ Green Label Plus: CRI Green Label Plus GLP1171, Pre-Consumer Recycled Content: 57%, NSF 140: EcoFlex NXT - NSF 140 Gold, Declare Label: Declared Red List Free</p>
Notes	Installation method: Brick Ashlar

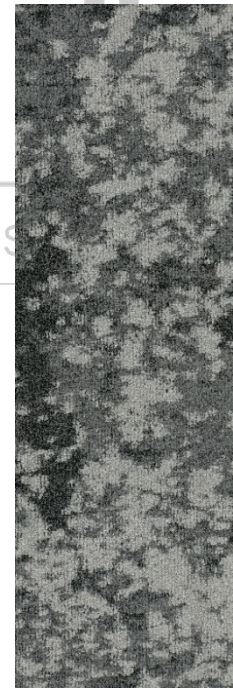

Room Finish Schedule	
Code	TL-1
Description	Mosaic Floor Tiles
Manufacturer	Jeffrey Court
Product/Style Name	The Press: Tribune Mosaic
Product Number	14205
Product Finish/Color	Navy
Dimension/Size	15.125" w x 13.125" h x 6mm
Location	Bathrooms
Technical Specifications	Design: Finish: Matte, Coverage Per Piece (SF): 1.378
Notes	Installation Method: Standard Mosaic Installation Method, Grout: TEC® AccuColor EFX® Epoxy Special Effects Grout (440) 949 Silverado (Light Gray), Sustainability: Contributes to LEED®, VOC 0, Contains 12% pre-consumer recycled material

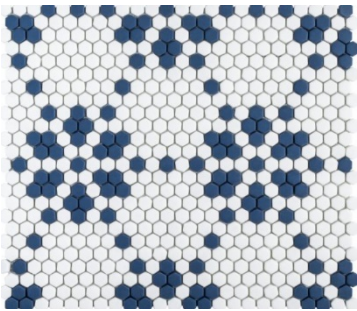

Room Finish Schedule	
Code	TL -2
Description	Wall Tile in Kitchen in Herringbone Pattern
Manufacturer	Fireclay Tile
Product/Style Name	Slate Blue
Product Number	N/A
Product Finish/Color	Slate Blue
Dimension/Size	2" w x 4" l
Location	Kitchen Wall
Technical Specifications	Design: Acid Sensitivity: None, Breaking Strength: 381 lbs., Scratch Hardness: 6.0 mohs Sustainability: LEED Qualifications: MR 4.1/4.2: Recycled Content - MR 5.1./5.2: Regional Materials - EQ 4.2: Low-Emitting Materials, All glazes are 100% lead-free
Notes	Installation Method: Herringbone Pattern Grout: TEC® AccuColor EFX® Epoxy Special Effects Grout (440) 949 Silverado (Light Gray), Sustainability: Contributes to LEED®, VOC 0, Contains 12% pre-consumer recycled material



Room Finish Schedule	
Code	CT-1
Description	Countertop
Manufacturer	Cambria
Product/Style Name	Bellwater™
Product Number	N/A
Product Finish/Color	N/A
Dimension/Size	Specific to Layout
Location	Kitchens, Bathrooms
Technical Specifications	Sustainability: NSF Certifications, LEED Certified, Kosher Certified, Declare
Notes	Clean with Simple Green® cleaner



Room Finish Schedule	
Code	CB -1
Description	Cabinet Finish Door Style and Color
Manufacturer	Kraftmaid
Product/Style Name	Elias Full
Product Number	AL2M6
Product Finish/Color	Bonsai
Dimension/Size	Reference Construction Documents
Location	Kitchens, Bathrooms, Entry/Mud Room
Technical Specifications	Design: Solid wood door frame with 2 3/4" stiles and rails, concealed hinge, hardware required, Overlay: Full Overlay
Notes	Reference Construction Documents



Room Finish Schedule	
Code	PL-1
Description	Cabinet Hardware Pulls
Manufacturer	Richelieu
Product/Style Name	Contemporary Brass Pull - 50755
Product Number	BP5075535195
Product Finish/Color	Brushed Nickel
Dimension/Size	6"
Location	Cabinet Drawers
Technical Specifications	Meets LEED Standards and Certifications, Constructed out of Solid Brass
Notes	Refer to Construction Documents



Room Finish Schedule	
Code	KN-1
Description	Cabinet Hardware Knob
Manufacturer	Richelieu
Product/Style Name	Contemporary Brass Knob - 52155
Product Number	BP52155125195
Product Finish/Color	Brushed Nickel
Dimension/Size	1 ¼" w
Location	Cabinet Doors
Technical Specifications	Meets LEED Standards and Certifications, Constructed out of Solid Brass
Notes	Refer to Construction Documents



Room Finish Schedule	
Code	WC-1
Description	Wallcovering
Manufacturer	Maharam
Product/Style Name	Lever
Product Number	300051
Product Finish/Color	002 Moonglow
Dimension/Size	52" w, Repeat 24" (Vertical)
Location	Living Room
Technical Specifications	<p>Design: Content: 100% Cellulose, Finish: Washable, Backing: Polyester, Traffic: Moderate-Suitable for heavy duty applications with the exception of high traffic corridors</p> <p>Performance: Flammability: This textile meets all appropriate flammability requirements for walls - ASTM E 4 Adhered flame 10, smoke 0, Lightfastness: Grade 4, 40 Hours</p> <p>Sustainability: Greenguard and Greenguard Gold Certified, LBC Red List Compliant, Contains Bio-Based Materials, FR Free, PFC-Free</p>
Notes	Installation Method: Standard wallpaper installation with standard repeat, reference installation guide for more information

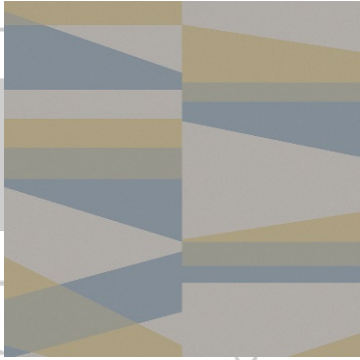

Room Finish Schedule	
Code	P-1
Description	Paint
Manufacturer	Sherwin Williams
Product/Style Name	Interior Paint
Product Number	SW 7058
Product Finish/Color	Magnetic Gray
Dimension/Size	N/A
Location	All walls except wall with wallcovering
Technical Specifications	N/A
Notes	R: 178 G: 181 B: 175, install after walls have been primed with Sherwin Williams LOXON® Primer/Finish



S H E P A R D , S

D I S T R I C T

L G B T Q I A + H o u s i n g

Lighting Schedule

Lighting Schedule	
Code	L-1
Product/Style Name	Noreen Pendant
Fixture Type	One-Light Glass Pendant
Manufacturer	Arteriors Contract
Item/Model Number	N/A
Description	Glass, Iron, Vintage Brass Canopy
Dimension/Size	10"d x 17"h
Quantity	12
Lamp Source	A19 Incandescent/LED 120V
Location	Above Kitchen Island
Notes	Reference Construction Documents for placement



Lighting Schedule	
Code	L-2
Product/Style Name	Hampton Vanity Light
Fixture Type	Vanity Light/Bar Light
Manufacturer	Arteriors Contract
Item/Model Number	49152
Description	Vintage Silver, Steel
Dimension/Size	22" w x 10" h
Quantity	12
Lamp Source	B10 Incandescent/LED
Location	Bathroom
Notes	Reference Construction Documents for placement



Lighting Schedule	
Code	L-3
Product/Style Name	Tarbell Semi-Flush
Fixture Type	Semi-Flush Mount Chandelier
Manufacturer	Arteriors Contract
Item/Model Number	49269
Description	Acrylic, Steel, Silver, Polished/Frosted Nickel
Dimension/Size	19.5" d x 14.5" h
Quantity	16
Lamp Source	LED
Location	Bedroom
Notes	Reference Construction Documents for placement, Lead time of 90 days



Lighting Schedule	
Code	L-4
Product/Style Name	PR6CP LED Series
Fixture Type	Recessed Can Lighting - 1500 lm
Manufacturer	Halo
Item/Model Number	PR6/PR6M
Description	6-inch LED self-flanged, lensed downlight and wall wash
Dimension/Size	6" d
Quantity	N/A
Lamp Source	LED
Location	Located throughout interior space
Notes	Reference Construction Documents for placement, 90 CRI, 3000K, dimmable, UL Listed



Lighting Schedule	
Code	L-5
Product/Style Name	Recessed Ceiling Bathroom Exhaust Fan with LED Light
Fixture Type	Recessed Can Lighting with Exhaust Fan
Manufacturer	NuTone
Item/Model Number	744LEDNT
Description	Recessed LED Fan/Light
Dimension/Size	6" d
Quantity	11
Lamp Source	LED
Location	Bathroom
Notes	Reference Construction Documents for placement, Quiet motor operate at 1.5 sones, dimmable, UL Listed, Energy Star



Ideation/Schematic Sketches

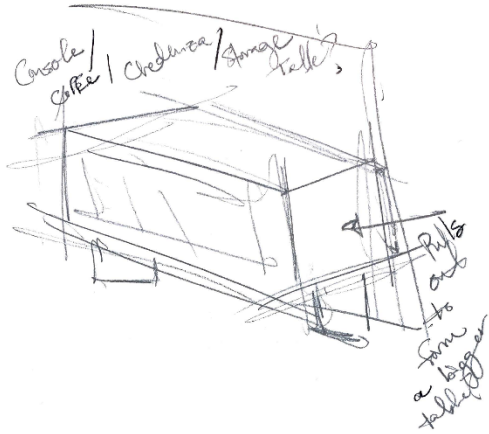

U I U I

L G B T Q I A

A R D , ' 0

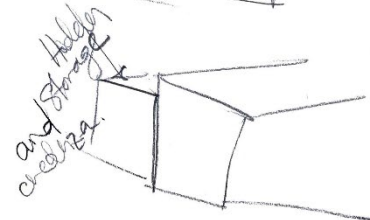
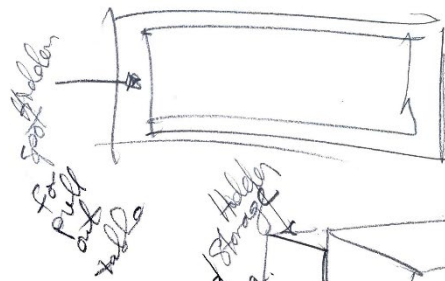
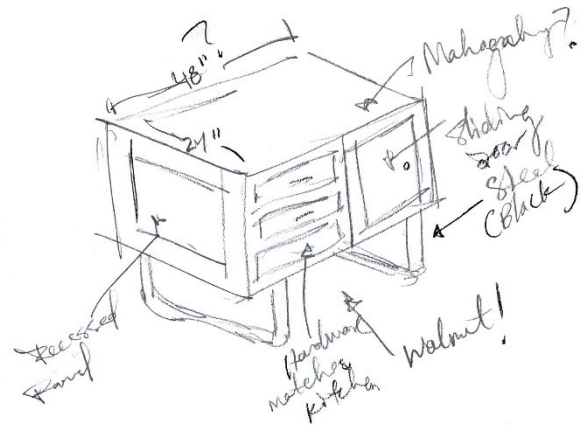

Study Model - 3D Model

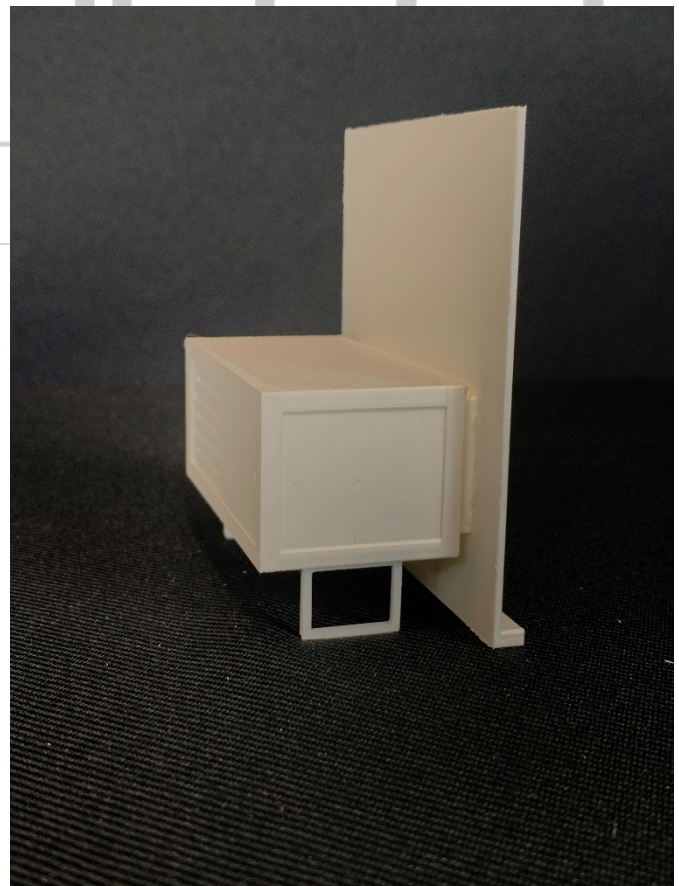



P A R D , S _____

D I S T

L G B T Q I A +





Works Cited

Manly, J. (August 29, 2019). Dorothy Day Food Pantry Informational Tour. Personal Collection of Jim Manly, Dorothy Day Food Pantry, Fargo, ND.

McClaflin, B. (September 12, 2019). Personal interview.

National Alliance to End Homelessness. (2019). *Incidence and Vulnerability of LGBTQ Homeless Youth*(Report No. 2). Retrieved from HUD Exchange:
https://b3cdn.net/naeh/1f4df9fc5fcad14d92_vim6ivd15.pdf

Hunter, E. (2008). WHAT'S GOOD FOR THE GAYS IS GOOD FOR THE GANDER: MAKING HOMELESS YOUTH HOUSING SAFER FOR LESBIAN, GAY, BISEXUAL, AND TRANSGENDER YOUTH. *Family Court Review*, 46: 543-557.
doi:10.1111/j.1744-1617.2008.00220.x

Gibson, D. (2009). *The Wayfinding Handbook: Information Design for Public Spaces*. New York: Princeton Architectural Press.

McCoy, J. (2012), Sustainability: Environmentally Responsible Interior Design. *Journal of Interior Design*, 37: 5-6. doi:10.1111/j.1939-1668.2011.01070.x

Pohlen, Tobias et al. "Semantic Segmentation of Modular Furniture." *2016 IEEE Winter Conference on Applications of Computer Vision (WACV)*. IEEE, 2016. 1-9. Web.

Braham, W.W. (2002). *Modern Color/Modern Architecture: Amedee Ozenfant and the Genealogy of Color in Modern Architecture*.